

# THERMO-MECHANICAL DESIGN OPTIMIZATION OF CORDIERITE–MULLITE BASED KILN FURNITURE

M. Farzalipour Tabriz and M. Ghassemi Kakroudi\*

mg\_kakroudi@tabrizu.ac.ir

Received: January 2010

Accepted: November 2010

\* Department of Materials Engineering, Faculty of Mechanical Engineering, University of Tabriz, Tabriz, Iran.

**Abstract:** Cordierite-Mullite based kiln furnitures are widely used in fast-firing of ceramic products because of their low thermal expansion which confer them a very good ability to thermal shock resistance. Difference in CTE of constituent phase can develop damage during thermal cycling due to internal stresses. Increase in industrial competitiveness leads to the development of new means for extending refractory life and increasing reliability of industrial tools so investigations regarding the structural/mechanical behaviour of refractory systems are becoming essential. In this paper, Thermo-mechanical design of commercial Cordierite-Mullite based kiln furniture was investigated by using finite element method (FEM) and possible solutions for improvement of working life have been considered. The results indicated that the change of the kiln furniture geometry can decrease the maximum thermo-mechanical stress in study conditions which can prolong the refractory service life. Obtained results indicate the existence of an optimal thickness for the section under maximum thermo-mechanical stress. Increasing filet radius of ring region from 3 to 9 mm decreases thermo-mechanical stress value from 113 to 93 MPa.

**Keywords:** kiln furniture, cordierite-mullite refractory, finite elements analysis

## 1. INTRODUCTION

Thermo-mechanical analysis enables product design for high temperature applications where a product's performance depends on its response to thermal loads. These loads can happen in service or during manufacture process or both. The response can include stress, strain or temperature variation which is where thermo-mechanical modeling has the ability to examine causes and effects which can't be measured experimentally. For example, the entire temperature profile of a furnace heated to 1600°C can be studied more cost effectively than it can be easily measured. Today, finite element analysis (FEM) is more and more applied to predict the structural integrity of components [1].

The refractory materials are subjected to strong thermomechanical load due to the temperature gradient through the thickness and the temperature cycles of the process. The resulting damage of refractory is very important for the prediction of service life duration. If a part of the refractory is too much damaged and subjected to very high temperature, it gets pierced and a catastrophic failure of the structure can occur [1-4]. Consequently, it is essential for designing to compute the mechanical stress in the

refractory and specially to check that the damage of the refractory is small enough.

The kiln furniture are subjected to severe solicitations, especially from thermomechanical point of view and can be degraded by a combination of several mechanisms, mainly thermal shock, and mechanical loadings. The behaviour of these materials face to those mechanisms is influenced by many factors such as their chemical composition, their microstructure as well as their phase transformation, which occurs at high temperature during firing process, and/or in service [5].

Cordierite–mullite composites have found increasing applications as refractory materials in the context of recent developments in ceramic industry as support parts in furnace. These refractories exhibit in general a complex microstructure characterized by crystalline phases of different thermal expansion coefficients ( $1.5\text{--}3 \times 10^{-6}$  for cordierite and  $4\text{--}6 \times 10^{-6}$  K<sup>-1</sup> for mullite), and elastic moduli and a residual silicate glassy phase. These materials can develop damage during thermal cycling due to high internal stresses [6]. In the case of refractory materials, the difference in thermal expansion between the different aggregates, or between aggregates and matrix, can induce

extensive microcracking network during cooling from firing temperature or/and during thermal cycling in using conditions [7-10].

The thermomechanical constrains may lead to frequent failures due to degradation of these refractories, through cracking, spalling of materials, by creep rapture.

Because of increasing competitiveness in industry, different means of extending refractory life and increasing reliability of industrial tools are being pursued and investigations regarding the structural\mechanical behaviour of refractory systems are becoming essential.

Up to now, the design of refractory kiln furniture has been conducted in conventional ways. This approach has permitted considerable progress; however, it considerably increases the time and cost due to the on trial-and-error method used.

In a design process steps to prevent substantial failure and damage of a refractory under thermal load my involve [1, 11]:

- selection of compatible refractory materials;
- rational thermomechanical analysis and design toward developing acceptable stress distributing;
- determination of optimal operating condition (specially heating scheme)

During the operating cycles, kiln furniture undergo complex mechanical and thermal conditions. The complicated geometry configurations combined with the developed steep temperature gradients, enforce failures which reduce the reliability standards and substantially increase the manufacturing or maintenance costs.

The objective of this paper is to provide an understanding of the thermo-mechanical behaviour of refractory kiln furniture.

## 2. MATERIALS AND EXPERIMENTAL PROCEDURES

### 2.1. Material and Sample Preparation

A commercial cordierite-mullite refractory supplied by SRPM (Sagar and refractory parts

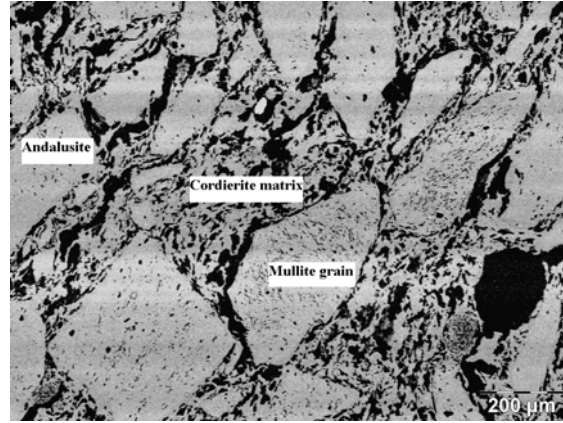

Fig. 1. Micrograph of cordierite mullite refractory.

manufacturing) Company, Iran, is considered here. This refractory made of andalusite aggregates, talc and clay that fired at 1350°C.

This material is presented here can be roughly considered as a composite made of mullite and residual andalusite grains in a cordierite and amorphous matrix (Fig.1). Table 1 shows the chemical compositions and some physical properties of the cordierite-mullite refractory supplied by the manufacturer.

This refractory is classically used as kiln furniture for porcelain manufacturing. With a very low coefficient of thermal expansion, it has an excellent thermal shock resistance.

The industrial investigation highlighted that the phase composition of the refractory contained

Table 1. Chemical analysis and physical properties of the cordierite mullite refractory.

Al <sub>2</sub> O <sub>3</sub> (wt%)	48-52
SiO <sub>2</sub> (wt%)	40-45
MgO (wt%)	4
Fe <sub>2</sub> O <sub>3</sub> (wt%)	1.2
Porosity (%)	19-22
Density (kg/cm <sup>3</sup> )	2.2-2.3
MOR (MPa)	15-20
α (10 <sup>-6</sup> K <sup>-1</sup> )	3-3.5

**Table 2.** Thermal and elastic properties of each component of the composite refractory.

	Density gr/cm <sup>3</sup>	Thermal expansion coefficient (10 <sup>-6</sup> K <sup>-1</sup> )	Young's modulus (Gpa)
Cordierite	2.65	1.4 – 2.6	132
Mullite	3.05	4.5 – 5.3	220
Andalusite	3.15	8	145

35% mullite, 39% cordierite and 26% non-mullitised andalusite that leading to a significant thermal expansion mismatch between different phases (Table 2).

Difference of thermal expansion between the constituents of refractory materials can lead, during heating and cooling stages, to the development of a large microcracks network within the microstructure, which strongly affects the thermomechanical properties.

**2.2 Engineering Analysis Using FEM (Finite Element Method)**

The pressure towards increased efficiency and reduction of the development and manufacturing costs and time has always pushed engineers to develop better and faster design methods for reliable products [8]. Among general computational techniques, which have been developed to treat thermo-mechanical problems, it must be acknowledged that the finite element method (FEM) has hitherto been the most successful. This method has been used successfully for studying thermo-mechanical behavior of refractories in various conditions [9, 10, 12-15].

The object of a simulation is to provide insight into the design of refractory materials to better resist the stress environments in refractory components under various operating conditions. Information is also provided on the mechanisms of the origin of the stress states and how they relate to the component fracture. An accurate thermomechanical analysis method, on which a rational design approach for the refractory can be based, is complicated by many factors. These factors include: loading conditions, material modelling, behavioural knowledge for the refractory, complex non-linear mechanics, numerical analysis, etc [14]. Controlling the stresses requires the formulation of an optimum combination of structure and properties, enabling the system to fulfil its function whilst deteriorating at the slowest possible rate. Its structure is defined by the shape and the size of the refractory.

The finite element method (FEM) is a necessary tool for conducting a reliable refractory investigation. A refractory investigation is usually conducted in two steps:

- The first is an evaluation of the thermal response of the system, which may be both steady-state and transient;

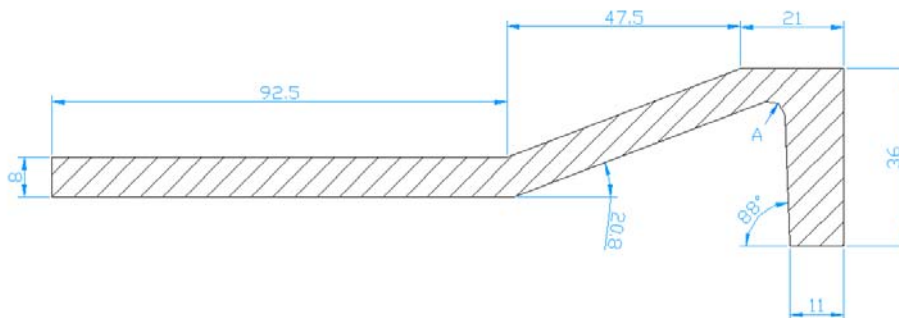

**Fig. 2.** Geometry of the refractory models.

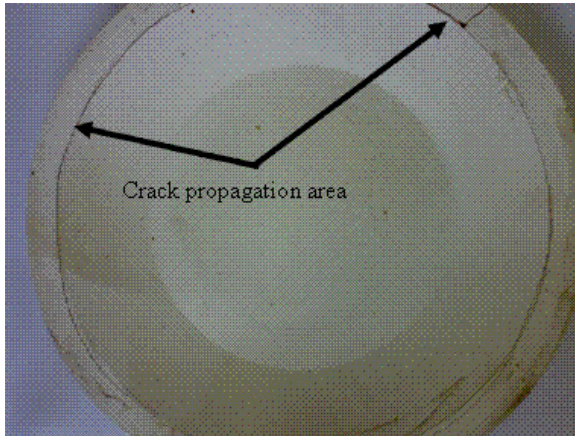

Fig. 3. Typical cracking scheme in refractories.

- The second step of the analysis consists in evaluating the thermal stresses within the system.

Figure 2 illustrates the schematic sketch of kiln furniture. Improper design of kiln furniture can intensify the damages resulted from the microstructure origins by imposing excess stress which results in early failure of refractories as it can be seen in figure 3.

Therefore, by modifying the kiln furniture design for decreasing maximum stress which is the place of crack nucleation, we can improve the working life of them. Some of the effective solutions are listed below:

- increase of kiln furniture height to avoid superposition of mechanical and thermal stresses
- increase of leg thickness to decrease

mechanical stress value

- increase of A radius to increase the thickness of ring region

It is obvious that by increasing the thickness of section under load, mechanical stress will decrease but it will result in increase of kiln furniture weight and the force exerted to the refractories in bottom of columns. Also due to low thermal conductivity it will increase the temperature gradient in refractories and increase the thermal stress. By considering that the height of kilns are fixed so increase in height of the kiln furniture will result in decrease of the number of them that can be loaded to the kiln in each column which is not economically favourable.

In this article the third approach is mainly considered. Change in A radius from 1 to 11 mm (3mm in original sample) has been investigated.

In this study, commercial FEM software: ABAQUS 6.6 was used for numerical calculation of stress in models. Due to existence of corners with high angle, meshing of sample was done using C3D10MT elements that are quadratic tetragonal elements with 10 nodes. The mesh around the stress concentration regions was made finer than those in the other areas.

3D meshed model of kiln furniture is shown in figure 4.

Material properties were assumed to be isotropic and linearly elastic; their values are shown in Table 3.

In investigated industrial kilns, 15 kiln furniture stack up in a column, each containing a

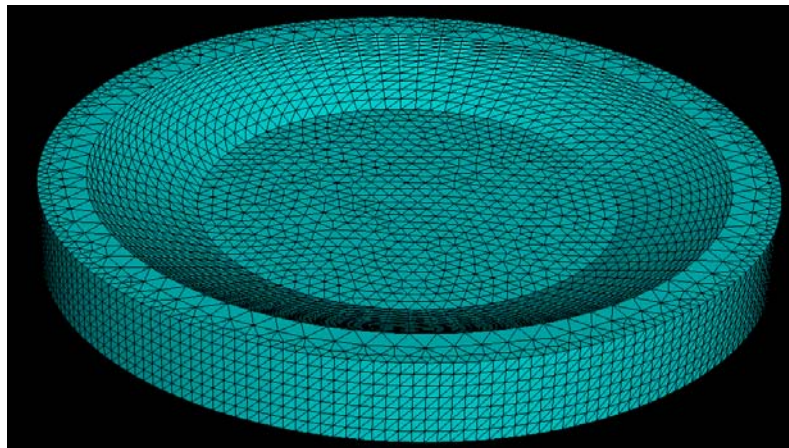

Fig. 4. 3D geometry and finite element mesh of models.

**Table 3.** Physical properties of the cordierite-mullite refractory

Properties	value
Density	$1910 \frac{kg}{m^3}$
Thermal conductivity	$1 \frac{W}{m.K}$
Thermal capacity	$1100 \frac{J}{kg.K}$
Coefficient of thermal expansion	$3.03 \times 10^{-6}/K$
Young modulus	34000 MPa
Poisson ratio	0.2

porcelain body of about 500g and they are heated to 12°C/min up to 1380°C and cooled 20°C/min.

### 3. RESULTS AND DISCUSSION

The experimental results show that the level of mechanical resistance of the refractory material depends on the shape of the sample and the boundary conditions.

Maximum mechanical stress is applied to the bottom sample in the column in working condition, so loading condition of this sample was used for the whole models. Mechanical and thermo-mechanical stress distribution in original samples are shown in figure 5.

The effects of increase refractories height and their legs' thickness on stress profile of refractory samples are shown in figure 6. Although these changes are not preferred but decrease of the stress values and changes in stress profiles are obvious.

The variations of maximum mechanical and thermo-mechanical stress of models with various curve radiuses "A" are listed in table 4.

The results indicate that by increasing curve radius up to 9 mm, both mechanical and thermo-mechanical stresses decrease, but after 9 mm, the sample weight increases so increase of thickness section overcome control the stress values. So there is an optimum radius value for the samples

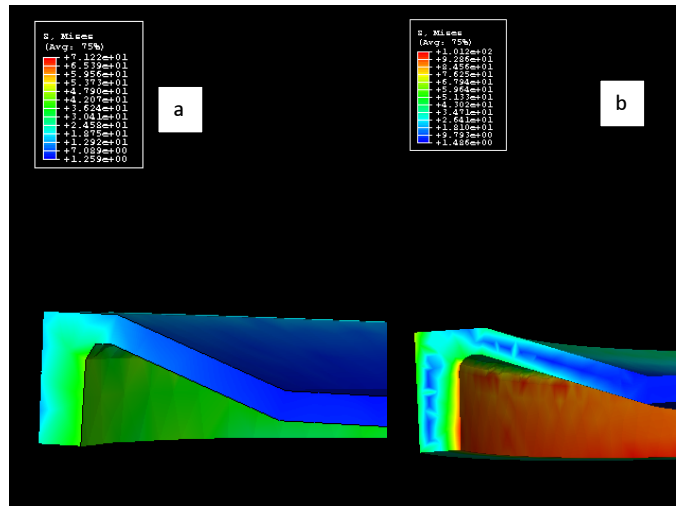

**Fig. 5.** Distribution of a) Mechanical stress and b) Thermo-mechanical stress in model.

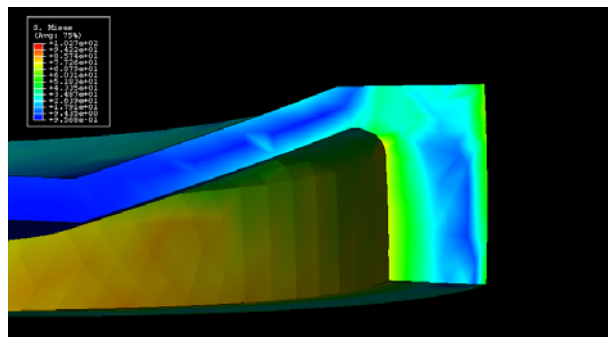

**Fig. 6.** Thermo-mechanical stress profile in models with a) longer legs and b) thicker legs.

**Table 4.** Variations of maximum mechanical and thermo-mechanical stress of kiln furniture by changing “A” radius.

A radii (mm)	Maximum Mechanical Stress (MPa)	Maximum Thermo-mechanical Stress (MPa)
1	91.5	120.7
۳	86.1	113.3
۵	71.2	101.2
۷	59.8	93.6
۹	57.2	93.1
۱۱	66.9	103.5

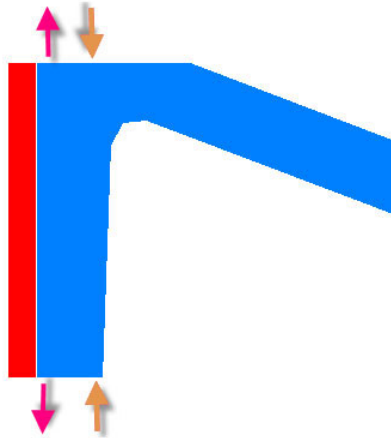

**Fig. 7.** Schematic representation of thermal stress effect on compressive stress of inner wall.

in this working condition.

Obviously there are two distinct regions in samples stress profile: The outer region expands due to temperature increasing and it applies the tensile stress to the colder region which is in contact with and a colder region that is expanding in interface with warmer region. For conservation of volume in cold region the opposite side of it should be compressed that intensify the compressive stress in inner side of the wall so thermal loading of refractories intensify the stress applied by mechanical means (Figure 7).

#### 4. CONCLUSION

In this paper, the failure of commercial kiln furniture used in ceramic industry was investigated and the solutions proposed to overcome this issue were investigated. The desired changes applied to the Finite Element model and thermo-mechanical analysis was done. One of the possible and commercially preferable

solutions was choose and its effect on maximum mechanical and thermo-mechanical stress profile investigated. The stress analysis reveals that the maximum compressive stress occurs at inner wall of model. Obtained results indicate the existence of an optimal thickness for the section under maximum thermo-mechanical stress. Increasing fillet radius of ring region from 3 to 9 mm decreases thermo-mechanical stress value from 113 to 93 MPa.

#### 5. ACKNOWLEDGEMENTS

Authors would like to thank the Tabriz University for financial support of this study and also Iranian SRPM Company for supplying the studied materials.

#### REFERENCES

- Rathner, R., Knauder, J., Weissensteiner, H., "Thermomechanical Behaviour of Refractory Lining with Special Emphasis on BOF-Vessels" Proceeding of the Unified Int. Tech. Conf. on Refractories, (UNITECR'91), Aachen, Germany, 1991, 12-18
- Chester, J. H., Refractories: Production and Properties, Metal Society, London, 1983 pp. 65-83
- Kingery, W. D., Bowen, H. K., Uhlman, D. R., Introduction to Ceramics, Second ed, Wiley Interscience, New York, 1976, pp. 773-797
- Schmitt, N., Berthaud, Y. Poirier, J., Tensile Behavior of Magnesia Carbon Refractories. J. Eur. Ceram. Soc., 20 (2000) 2239-2248.
- Serry, M. A., Telle, R., Thermomechanical properties of high alumina castables. J. Am. Ceram. Soc. Bull., 79 (2000) 71-75.
- Miyamoto, M., Onoye, T., Narita, K., Deformation and Failure of Blast Furnace Refractories with Joints at Elevated Temperature. Interceram (Special Issue)

- 32 (1983) 107-110.
7. Bejan, A., Tsatsaronis, G., Moran, M., *Thermal Design and Optimization*, Wiley-Interscience, 1995, pp. 25-42
  8. Janssens, K. G. F., Raabe, D., Kozeschink, E., Miodownik, M.A., Nestler, B., *Computational Materials Engineering*, Elsevier Inc., 2007, pp. 179-217
  9. Andreev, K., Harmuth, H., FEM simulation of thermomechanical behaviour and failure of refractories – a case study. *Journal of Materials Processing Technology*, 143-144 (2003) 72-77.
  10. Gruber, D., Andreev, K., Harmuth, H. FEM simulation of the thermomechanical behaviour of the refractory lining of a blast furnace. *Journal of Materials Processing Technology*, 155-156 (2004) 1539-1543.
  11. Chen, E. S., Buyukozturk, O. "Evaluation of an Integrated Design Process for Refractory Systems" *Proceeding of the Unified Int. Tech. Conf. on Refractories, (UNITECR'89)*, Westerville, OH, (1989) pp. 1328-1339
  12. Boisse, P., Gasser, A., Poirier, J., Rousseau, J. Simulation of thermomechanical behaviour of composite refractory linings, *Composites: Part B, J. Am. Ceram. Soc.* 32 (2001) 461-474.
  13. Suat, Y., Thermomechanical modelling for refractory lining of a steel ladle lifted by crane, *J. Steel res. Int.*, 74 (2003) 485-490.
  14. Gasser, A., Boisse, P., Rousseau, J., Dutheillet, Y., Thermomechanical behaviour analysis and simulation of steel/refractory composite linings. *J. Com. Sci. and Tech.*, 61 (2001) 2095-2100.
  15. Simonin, F., Olagnon, C., Maximilien, S., Fantozzi, G., Diaz, L.A., Torrecillas, R., Thermomechanical Behavior of High-Alumina Refractory Castables with Synthetic Spinel Additions, *J. Am. Ceram. Soc.*, 83 (2004) 2481 - 2490.