

EFFECTS OF A MODIFIED SIMA PROCESS ON THE STRUCTURE, HARDNESS AND MECHANICAL PROPERTIES OF Al-12Zn-3Mg-2.5Cu ALLOY

M. Alipour^{1, 2, 3*}, M. Emamy³, R. Eslami Farsani¹, M. H. Siadati¹ and H. Khorsand¹

* Alipourmo@ut.ac.ir

Received: January 2015

Accepted: August 2015

¹ Faculty of Materials Science and Engineering, K. N. Toosi University of Technology, Tehran, Iran.

² Department of Materials Engineering, Faculty of Mechanical Engineering, University of Tabriz, Tabriz, Iran.

³ School of Metallurgy and Materials Engineering, University of Tehran, Tehran, Iran.

Abstract: A modified strain-induced melt activation (SIMA) process was applied and its effect on the structural characteristics and hardness of the aluminum alloy Al-12Zn-3Mg-2.5Cu was investigated. Specimens subjected to a deformation of 40% at 300 °C were heat treated at various times (10-40 min) and temperatures (550-600 °C). Microstructural studies were carried out using optical and scanning electron microscopies (SEM). Results showed that the best microstructure was obtained at the temperature and time of 575 °C and 20 min, respectively. The hardness test results revealed superior hardness in comparison with the samples prepared without the application of the modified SIMA process.

T6 heat treatment including quenching to 25 °C and aging at 120 °C for 24 h was employed to reach to the maximum strength. After the T6 heat treatment, the average tensile strength increased from 231 MPa to 487 and 215 MPa to 462 for samples before and after strain-induced melt activation process, respectively. Ultimate strength of globular microstructure specimens after SIMA process has a lower value than as-cast specimens without SIMA process.

Keywords: Casting, Heat Treatments, Microstructure, Modified SIMA Process.

1. INTRODUCTION

The aluminum alloy 7075 was developed over 70 years ago. However, much research was performed on it in the past decade [1]. In this research, we focused on high strength 7xxx series wrought aluminum alloy which is typically used in aircraft structural parts and other highly stressed applications where very high strength and good resistance to corrosion are required [2-3]. There are many benefits from the use of grain refiners in aluminum alloy castings. For example, mechanical properties can be enhanced [4-5], susceptibility to hot cracking is reduced [6] and fluidity is improved [7-8].

The strain induced melt activation (SIMA) process has been used to enhance the mechanical properties of Al alloys in recent years. In this process, strain is stored in a billet and a global structure is evolved by the strain energy stored in the billet after reheating [Young and et al]. Parameters such as heating time, temperature and the degree of cold working are critical factors in controlling the semi-solid microstructures in the

SIMA process [7-9]. In this research, a modified version of the SIMA process was applied. The modified SIMA process involved homogenization and warm deformation instead of cold working in the conventional SIMA process [10]. It has been shown that the microstructure of an alloy prepared in the semi-solid state depends on its microstructure prior to partial remelting, so it is important to study the initial microstructure and subsequent evolution process during partial melting.

The main objective of this investigation was to study the effect of the modified SIMA process on the microstructure and hardness of the Al-12Zn-3Mg-2.5Cu alloy.

2. EXPERIMENTAL PROCEDURE

Industrially pure Al (99.8%), Mg (99.9%), Zn (99.9) and Cu (99.9%) were used as the starting materials. An electrical resistance furnace was used for heating/melting the pure metals during the alloy fabrication. Table 1 shows the chemical composition of the Al-12Zn-3Mg-2.5Cu alloy fabricated.

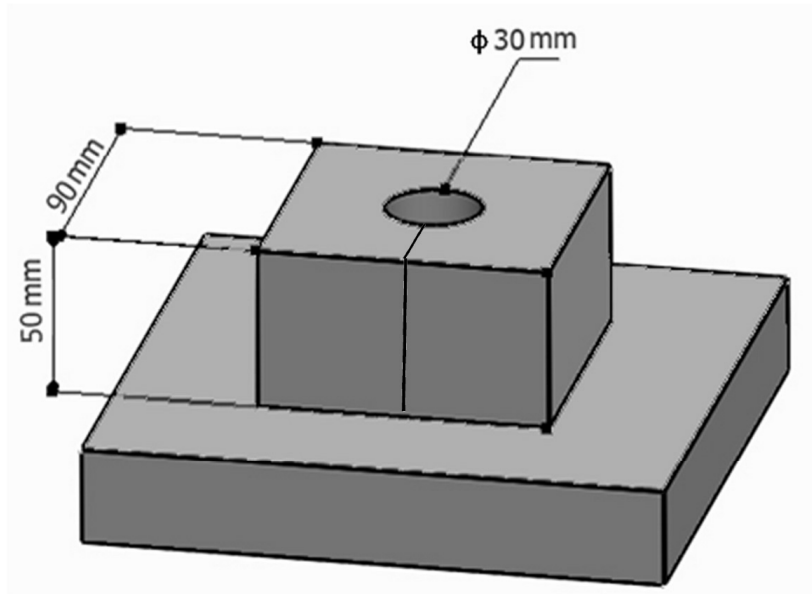

Fig. 1. Schematic drawing of casting mold specimen (scale: mm).

Table 1. Chemical composition of the primary ingots (wt.%).

Al	Zn	Mg	Cu	Ti	B	Fe	Si
Rem.	12.24	3.14	2.48	-	-	0.16	0.03

Degassing was conducted by submerging dry C_2Cl_6 containing tablets (0.3 wt% of the molten alloy). After stirring the molten alloy with a graphite rod for about 1 min and cleaning off the dross, it was poured into a cast iron mold schematically shown in Fig. 1. For all tests, the molten alloy was poured into the mold at 720 °C. For macrostructural studies, samples were selected from 20 mm of the bottom of each casting.

The modified SIMA process was applied to the specimens before microstructural studies. For the modified SIMA process (Fig. 2), the cylindrical cast specimens (Φ 30 mm \times 50 mm) were homogenized at 460 °C for 8 h and then they were quenched in water (25 °C). After reheating the homogenized specimens to 300 °C, warm deformation was conducted by a 400 ton hydraulic press.

For all specimens, a constant deformation (40%) was selected to provide adequate strain as required in the SIMA process. The amount of the stored energy by warm working and its distribution are the most critical factors in the SIMA process since they control the recovery and recrystallization kinetics

and the uniformity of the resultant microstructure. The deformed samples were then heated to various temperatures within the range of the liquidus–solidus zone (550–600 °C) and held at those temperatures for various time periods (10–40 min) as listed in Table 2.

For structural studies, an optical microscope equipped with an image analysis system (Clemex Vision Pro. Ver.3.5.025) and a scanning electron microscope performed in a Cam Scan MV2300 SEM, equipped with an energy dispersive X-ray analysis (EDX) accessory were used. The cut sections were polished and then etched by Keller’s reagent (2 ml H, 3 ml HCl, 5 ml HNO₃ and 190 ml H₂O) to reveal the structure. The average grain size of the specimens was measured according to the ASTM: E112 standard.

Hardness test was carried out according to ASTM: E10 standard using an Eseyaw tester (Brinell hardness: 30 kg force and indenter 2.5 mm). A comparison was made between the hardness results of the specimens prepared before and after the SIMA process.

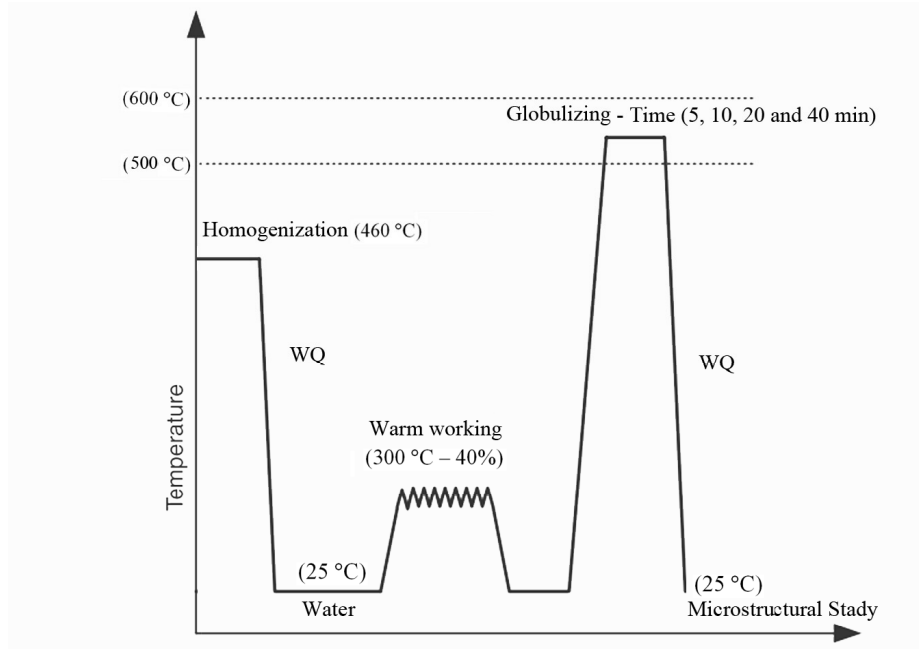

Fig. 2. Schematic illustration of the modified SIMA process.

Table 2. Mechanical properties of wrought Al-12Zn-3Mg-2.5Cu alloy under T6 treatment conditions.

properties	σ_{uts} (Mpa)	yield strength	Elongation (%)
Al-12Zn-3Mg-2.5Cu	231±15	139±5	0.61
Al-12Zn-3Mg-2.5Cu-T6	487±17	425±9	1.2

Before testing, T6 heat treatment was applied to the castings containing optimum amount of the master alloy, i.e. 0.3%B (3.75 wt.% Al-8B) and all SIMA specimens. For this purpose, the specimens were subjected to T6 heat treatment including heating up to 460 °C for 8 h, quenching in water (25 °C) and aging at 120 °C for 24 h [3]. For tensile tests, specimens were machined according to ASTM, B557 M-94 standard.

3. RESULTS AND DISCUSSION

3.1. Structural Characterization in As-Cast Condition

Fig. 3 shows the structures of the Al-12Zn-3Mg-2.5Cu alloy in the as-cast condition. Fig.

3(a) shows that the alloy has a fully equiaxed grain structure and Fig. 3(b) shows its SEM back scattered images. The segregation of solutes occurred during solidification of the alloy leading to the high concentration of Cu, Mg and Zn in the inter-dendritic eutectic regions. The microstructure of alloy contains primary α -phase (solid solution of aluminum) and second phases based on η -MgZn₂ (in eutectic region), S-Al₂-CuMg and T-Al₂Mg₃Zn₃ [10].

One inter-dendritic eutectic region at much higher magnification is shown in Fig. 4, along with line analyses of the region. T-phase is present mostly as divorced phase (also in some cases as part of the eutectic structure). S-phase exists in rather small volumes, entirely as a

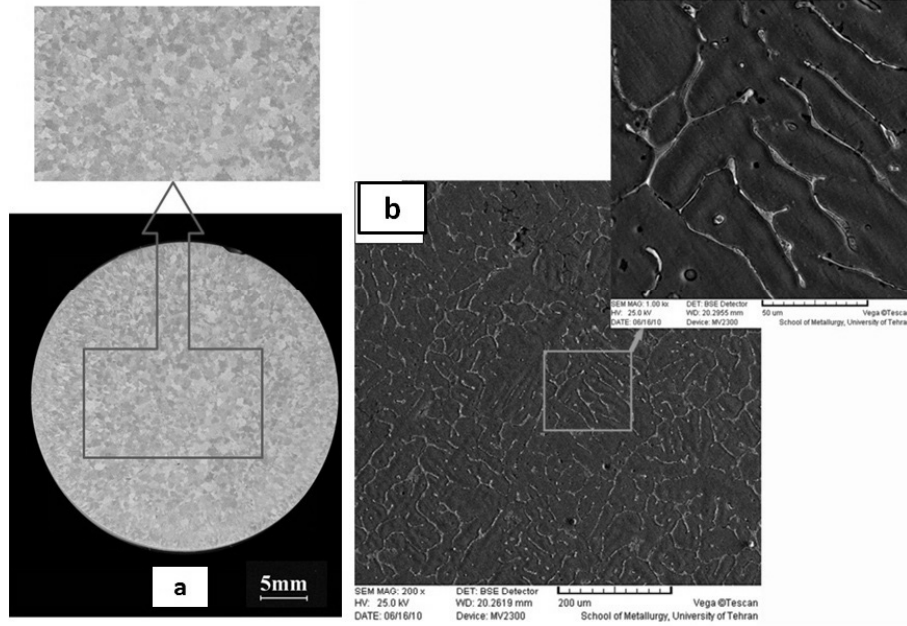

Fig. 3. (a) Macrographs and (b) SEM micrographs of specimens.

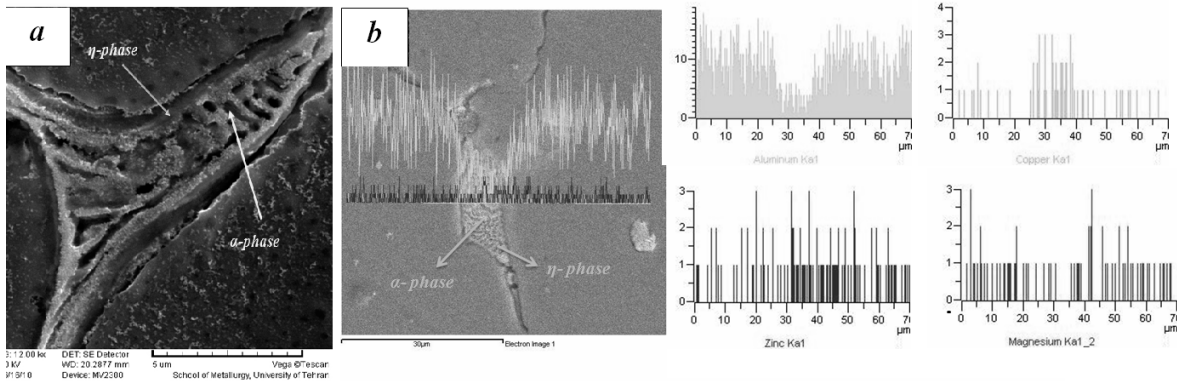

Fig. 4. (a) BSE image of the eutectic structure of as-cast sample (b) Results from line analysis in sample.

divorced phase with spherical morphology. As shown in Fig. 5, it is clear that the predominant eutectic structure includes α -Al and η -MgZn₂ phases. Cu is also present in average composition in the EDS analysis of the eutectic structure, Fig. 4. It is important to note that the solubility of η -phase for copper is relatively high, so it can be observed in the eutectic structure [11-13].

3. 2. Structural Characterization in SIMA Process

Figs. 6, 7 and 8 show the microstructures of specimens after applying different globalizing times and holding temperatures during the SIMA process. Comparing Figs. 6, 7 and 8, it is clear that the best microstructure pertains to the sample shown in Fig. 7(b) whose holding time and temperature were 20 min and 575 °C, respectively. The recrystallized grains merged

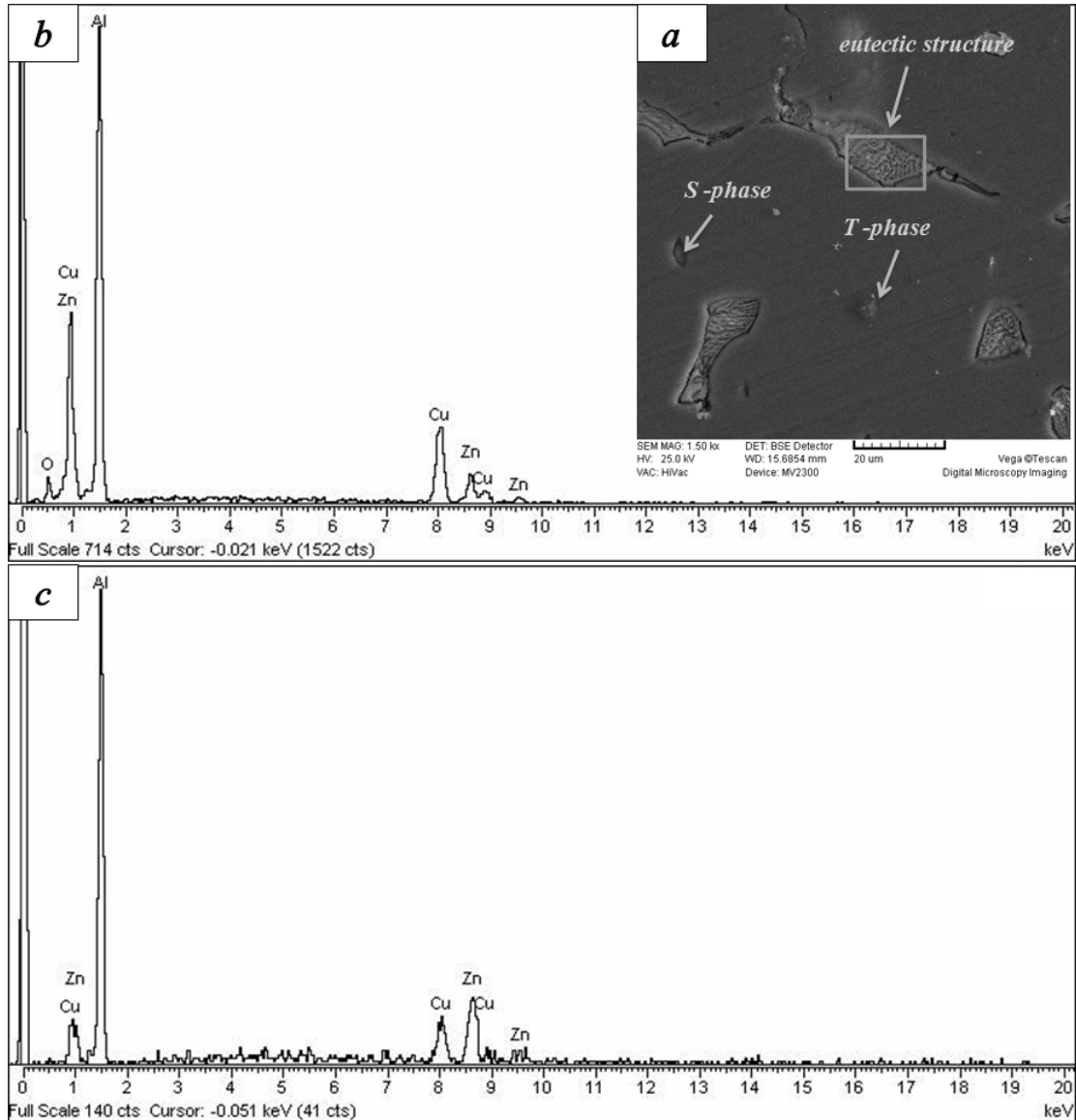

Fig. 5. (a) BSE image of the eutectic structure, S and T phase of sample unrefined (b) X-ray energy spectra of S phase, (c) X-ray energy spectra of T phase.

and grew as temperature rose. The average globule size decreased initially for the 20 min holding time and then increased in time. In Fig. 9, it can be observed that the minimum average globule size for the alloy is 69 μm. As expected, at shorter times only a small quantity of the eutectic phase melted, and at longer times most of the eutectic Zn located at the boundaries of primary phase melted. The longer times also resulted in grain coarsening such as that shown in Fig. 8(c) for the 40 min sample.

Generally, SIMA is considered as a process in which the basic forged, extruded or rolled bars are subjected to additional deformation to accumulate a large quantity of deformation energy and then heated to the semi-solid condition to transform the dendritic structure to a fine, uniform and spheroidal microstructure. The deformation energy accumulated by the increase in the dislocation density is closely related to the deformation process. It was well showed in the SIMA process that higher globalizing

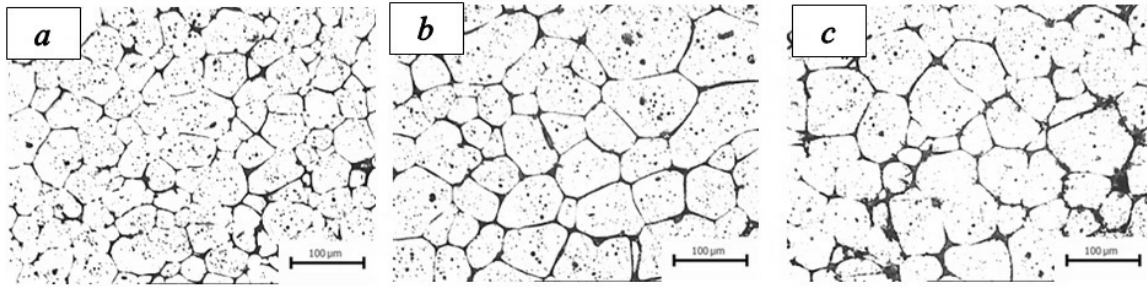

Fig. 6. Microstructure of 40% predeformed Al-12Zn-3Mg-2.5Cu alloy after holding at 550 °C for 10 min (a), 20 min (b) and 40 min (c).

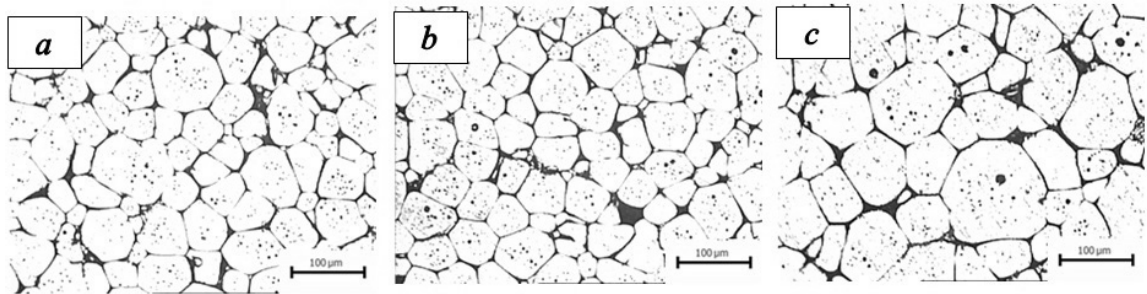

Fig. 7. Microstructure of 40% predeformed Al-12Zn-3Mg-2.5Cu alloy after holding at 575 °C for 10 min (a), 20 min (b) and 40 min (c).

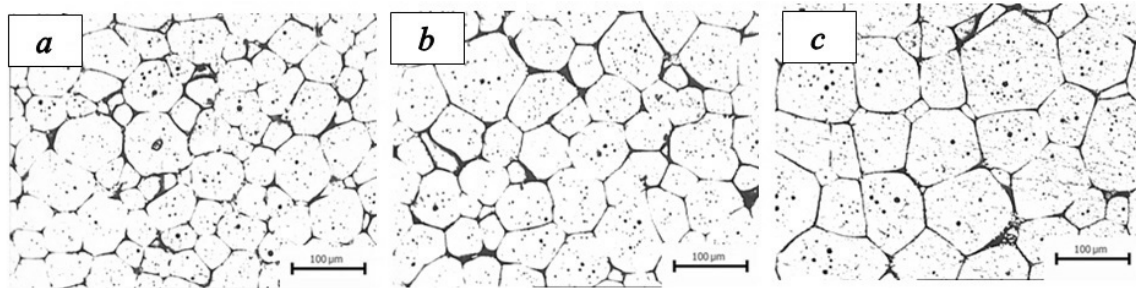

Fig. 8. Microstructure of 40% predeformed Al-12Zn-3Mg-2.5Cu alloy after holding at 600 °C for 10 min (a), 20 min (b) and 40 min (c).

temperature increases the amount of liquid at the grain boundaries. Due to the effects of surface tension and interface curvature, the convex edges of the dendrites melt and decrease the interface area of the dendrites leading to a lower free

energy. Moreover, the concentration of the solute in the concave parts of the grains is higher, which increases the amount of liquid in these areas. When the liquids of the two concaves contact each other, the grains separate into autonomous

small grains. It should be noted that higher heat treatment temperatures cause further dissolution of eutectics and spheroidization of the α -Al grains. At temperatures higher than the eutectic temperature, the eutectic phase dissolves completely and the atoms diffuse to the α -Al grains due to larger diffusion capacity and the solubility of the elements in the α -Al. Since the second arms are small, they coarsen, combine and disappear when the eutectics between them melt completely [13-16]. Results in this study showed that the structure of grains gently become irregular at smaller holding times. In the deformation stage, the samples accumulated enough deformation energy at the boundaries of grains and subgrains to provide the kinetics of partial remelting.

When the samples were heated to the semi-solid temperature, melting occurred at these boundaries and novel grains appeared. With increasing the holding time, the structure of these grains became larger and more spheroidal. The grain coarsening occurred by the mechanisms of

coalescence and Ostwald ripening [17]. The microstructure evolution to spheroidal structure was promoted by the reduction of the interfacial area between the solid and liquid phases. Clearly, adequate holding time ensured the complete evolution of the microstructure. The fine and spheroidal grains could only be acquired if the appropriate holding time is selected. The experimental results in this study support the deformation-recrystallization mechanism proposed by Doherty et al. [18] as the main mechanism responsible for the formation of the spheroidal microstructure via the SIMA process. According to the results shown in Fig. 9, the optimum time and temperature for the modified SIMA process is 20 min and 575 °C, respectively. Therefore, it can be concluded that the entire evolutionary microstructural processes of the pre-deformed alloy during heat treatment to the semi-solid state consist of four stages. First, the dendrites become oriented in the same direction. Secondly, the eutectics melt and the primary dendritic grains coarsen into interconnected non-dendritic grains

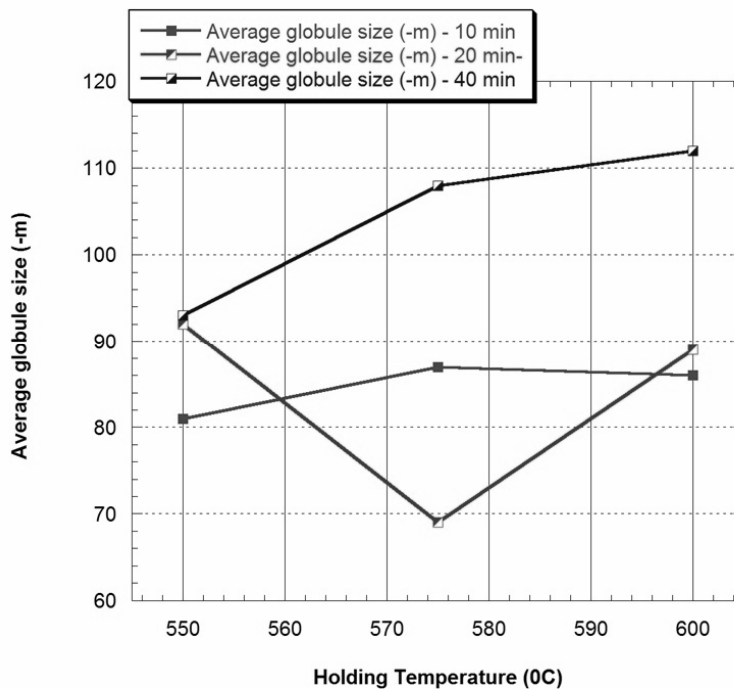

Fig. 9. Average globule size vs. holding temperature for 10, 20, 40 min. SIMA process - 40% predeformation.

and recrystallization occurs in the non-dendritic grains. Thirdly, the eutectics melt along the primary α -Al and the recrystallized grain boundaries and the new recrystallized grains merge and grow. Finally, the grains separate from each other and spheroidize. The microstructural evolution of the non-deformed alloy involves only three stages: the melting of the eutectics, the combining of the dendrites and the spheroidization of the combined dendrites [18].

In the SIMA process with adequate amount of predeformation, during the heat treatment process of the specimens, the solubility of elements in the α -Al increases and Al and Zn diffuse from the eutectic phase into the α -Al, which makes the eutectic phase to dissolve, the second arms to combine and the α -Al to grow. Because the diffusion of the atoms along the grain boundary is faster than that inside the grains, the concentrations of the solute at the

primary α -Al and recrystallized grain boundaries are higher. When the heat treatment temperature is higher than the eutectic temperature, the high concentration region begins to melt and liquid phases occur both at the grain boundaries and inside the grains. The amount of liquid increases and the grains separate from each other with increasing the temperature. Furthermore, due to the effect of interface curvature, the spheroidization of the grains takes place in order to decrease the free energy. In addition, under the effect of interface curvature, the convex edges melt and the grains spheroidize gradually with increasing heat treatment temperature or with prolonged holding time. Finally, the globular microstructures favor the formation of semi-solid. By increasing the holding time which enhances diffusivity of the atoms in the eutectic regions [18], all the above mentioned phenomena occur faster. Hence, the variations of the shape

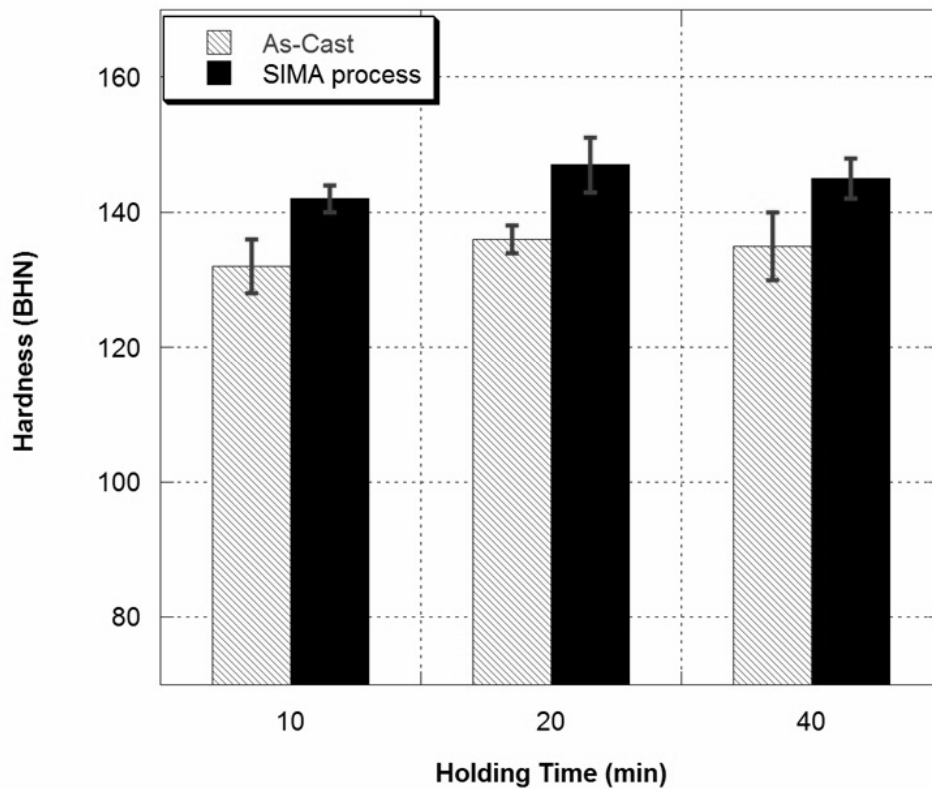

Fig. 10. Hardness of samples after and before SIMA process with holding time in 575 °C after a 40% predeformation.

factor with respect to the holding time and the discussed globularization mechanisms are similar to those mentioned for the holding temperature.

3. 3. Hardness Results

Fig. 10 shows the hardness results of the specimens before and after the SIMA process. There is a slight improvement in the hardness of the specimens after the SIMA process. Fig. 10 also shows the effect of warm working and heat treatment conditions on the hardness of the alloy. As expected, the hardness values of the specimens held for 20 min were found to be higher than those for the specimens at 575 °C. This may be attributed to the progress of recrystallization and reduction of lattice strains or residual stresses with increasing time and temperature. This may also be due to the solid solution hardening of Al-12Zn-3Mg-2.5Cu alloy by secondary solid elements at elevated holding time and temperature.

3. 4. Tensile Properties

Table 2 shows the mechanical properties of Al-12Zn-3Mg-2.5Cu alloy as standard conditions for comparing the different steps of processes in this study. In table 3, UTS, yield strength and elongation values of the specimens in the different conditions are shown. As it is shown in table 3, the average ultimate tensile strength (UTS) of the warm pressed specimens decreases

from 231 MPa to about 215 MPa after holding at 575 °C for 20 min without T6 heat treatment. But, due to the several mechanisms engaging in strengthening of Al 7xxx alloys, especially precipitation hardening, the dependence of the strength to grain size was unclear. Intermetallic compounds are brittle and considered as important crack initiating sites during loading. Several reports indicate that metastable coherent or semicoherent η precipitates are formed during aging treatment [19-23]. Fig. 11 shows the fracture surfaces of the unrefined and refined specimens in the different conditions. Ultimate strength of globular microstructure specimens has a low value which is due to the presence of shrinkage porosities inside the grains and boundaries which is illustrated. Table 3 shows that the ultimate strength of microstructure specimens has the highest value of all specimens with SIMA process in all conditions. According to table 3, elongation before fracture has the minimum value for globular microstructure specimens. As it can be seen, the elongated grains of Al matrix (bright regions) with intermediate compounds such as intermetallics are observed in Fig. 11. The precipitation hardening phase is $MgZn_2$, provided that the aging temperature is below 200 °C and also the Al-12Zn-3Mg-2.5Cu alloy, which has more than 1% Cu, precipitates $CuMgAl_2$ [23-25]. High elongation value in globular microstructure specimens is related to disappear shrinkage porosities inside the globular grains.

Table 3. The results of tensile and elongation of specimens.

properties	σ_{uts} (Mpa)	yield strength	Elongation (%)
Al-12Zn-3Mg-2.5Cu	231±15	139±5	0.61
Al-12Zn-3Mg-2.5Cu-T6	487±17	425±9	1.2
Al-12Zn-3Mg-2.5Cu-SIMA	215±14	135±11	0.63
Al-12Zn-3Mg-2.5Cu-SIMA-T6	462±17	410±12	2.22

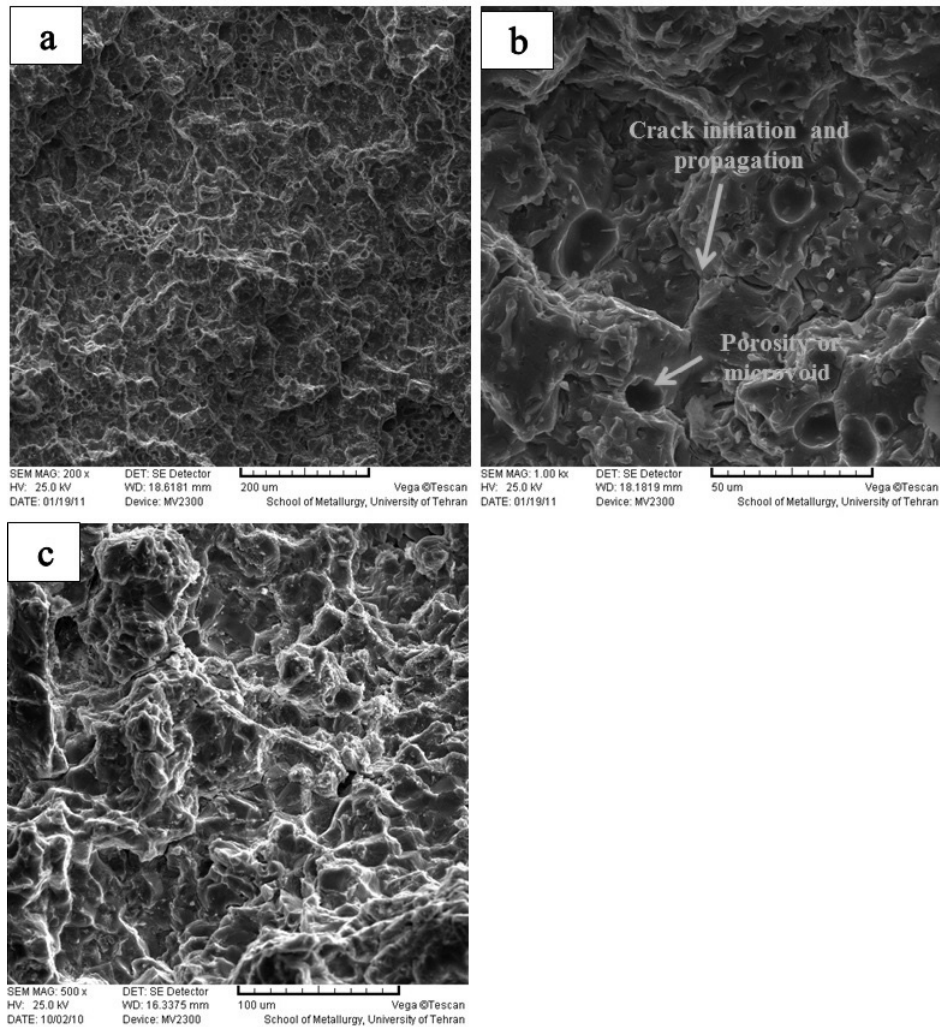

Fig. 11. Fracture surfaces of specimens (a-b) with T6 heat treatment, (c) without T6 heat treatment.

4. CONCLUSIONS

1. The optimum temperature and time for the best microstructure obtained by the application of the SIMA process were 575 °C and 20 min, respectively.
2. Increasing of the holding temperature in the SIMA process led to the coarsening of the grains for the same amounts of predeformation and holding time.
3. A dominant globular structure developed by the 40% predeformation. Further increase of the holding time altered the globularization of the microstructure.
4. The results indicated that with the increase of holding time, sphericity of particles increased, their size decreased and that sphericity takes place in lower reheating temperature. The optimum uniformity was obtained for holding time and temperature of 20 min and 575 °C, respectively.
5. The hardness of the specimens after the SIMA process improved.
6. Ultimate strength of as-cast specimens without SIMA process has a higher value than globular microstructure specimens after SIMA process.
7. With attention to presence of shrinkage porosities in grain boundaries, the fracture

occurred completely intergranular, and the grain deformation rarely happened which resulted brittle fracture for specimens.

ACKNOWLEDGEMENT

The authors would like to thank University of Tehran, K.N. Toosi University of Technology and University of Tabriz for financial support of this research.

REFERENCES

1. Alipour, M., Emany, M., Seyed Ebrahimi, S. H., Azarbarmas, M., Karamouz, M. and Rassizadehghani, J., "Effects of pre-deformation and heat treatment conditions in the SIMA process on properties of an Al-Zn-Mg-Cu alloy modified by Al-8B grain refiner". *Mater. Sci. Eng. A*, 2011, 528, 4482-4490.
2. Alipour, M. and Emany, M., "Effects of Al-5Ti-1B on the structure and hardness of a super high strength aluminum alloy produced by strain-induced melt activation process". *Materials. Design*, 2011, 32, 4485-4492.
3. Haghparast, A., Nourimotlagh, M. and Alipour, M., "Effect of the strain-induced melt activation (SIMA) process on the tensile properties of a new developed super high strength aluminum alloy modified by Al\5Ti\1B grain refiner". *Mater. Characterization*, 2012, 71, 6-18.
4. Alipour, M., Azarbarmas, M., Heydari, F., Houghoughi, M., Alidoost, M. and Emany, M., "The effect of Al-8B grain refiner and heat treatment conditions on the microstructure, mechanical properties and dry sliding wear behavior of an Al-12Zn-3Mg-2.5Cu aluminum alloy Materials". *Design*, 2012, 38, 64-73.
5. Li, Y., Li, P., Zhao, G., Liu, X. and Cui, J., "The constituents in Al-10Zn-2.5Mg-2.5Cu aluminum alloy." *Mater Sci Eng. A*, 2005, 397, 204, 8-16.
6. Wang, F., Xiong, B., Zhang, Y., Zhu, B., Liu, H. and Wang, Z., "Microstructure and mechanical properties of spray-deposited Al-10.8Zn-2.8Mg-1.9Cu alloy after two-step aging treatment at 110 and 150 °C." *Mater Charact*, 2007, 58, 82-86.
7. Cook, R., Cooper, P. S. and Kearns, M. A., "Benefits of master alloy melt treatments in the aluminum foundry industry", *TMS Light Metals*, 1996, 647-654.
8. Apelian, D., Sigworth, G. K. and Whaler, K. R., "Assessment of Grain Refinement and Modification of Al / Si Foundry Alloys by Thermal Analysis", *American Foundrymen's Society, Inc*, 1984, 297-307.
9. Metz, S. A. and Flemings, M. C., "The Merton C. Flemings Symposium on Solidification and Materials Processing", *USA publishers, Cambridge, MA, USA*, 28-30 June, 2000-2001, 181-188.
10. Dahle, A. K., Arnberg, L., Tondel, P. A. and Paradies, C. J., "Effect of grain refinement on the fluidity of two commercial Al-Si foundry alloys, *Metall*". *Trans. A* 8, 1996, 2305-2313.
11. Mollard, F. R., Flemings, M. C., Niyama, E. F., "Aluminum fluidity in casting", *J. Met.*, 1987, 11, 34-37.
12. Dong, J., Cui, J. Z., Yu, F. X., Ban, C. and Zhao, Z. H., "A new way to cast high-alloyed Al-Zn-Mg-Cu-Zr for super-high strength and toughness", *Metall. Trans. A*, 2004, 35, 2487-2494.
13. Young, K. P., Kyonka, C. P. and Courtois, J. A., "Fine grained metal composition", *U. S. Patent*, 1983, 4, 415, 374.
14. Kapranos, P., "Semi-solid metal processing: an environmentally friendly process". *Mater World*;September, 1994, 465-467
15. Hirt, G., Cremer, R., Winkelmann, A., Witulski, T., Zillgen, M., "Semi solid forming of aluminum alloys by direct forging and lateral extrusion", *J. Mater. Process. Technol.*, 1994, 45, 359-364.
16. Turkeli, A. and Akbas, N., "Formation of non-dendritic structure in 7075 wrought aluminum alloy by SIMA process and effect of heat treatment, in: *Proceedings of the Fourth International Conference on Semi-solid Processing of Alloys and Composites*", Sheffield, UK, 1996, 71-74.
17. Sang-Yong, L., Jung-Hwan, L. and Young-Seon, L., "Characterization of Al 7075 alloys after cold working and heating in the semi-solid temperature range", *J. Mater. Process. Technol.*, 2001, 111, 42-49.
18. Song, Y. B., Park, K. T., Hong, C. P.,

- “Recrystallization behavior of 7175 Al Alloy during modified strain-induced melt-activated (SIMA) process”, *Mater. Trans.*, 2006, 47, 1250-1256.
19. Mondal, C. and Mukhopadhyay, A. K., “On the nature of T(Al₂Mg₃Zn₃) and S(Al₂CuMg) phases present in as-cast and annealed 7055 aluminum alloy”, *Mater. Sci. Eng. A*, 2005, 391, 367-376.
 20. Wang, J. G., Lu, P., Wang, H. Y., Liu, J. F. and Jiang, Q. C., “Semisolid microstructure evolution of the predeformed AZ91D alloy during heat treatment”. *J. Alloys Compd*, 2005, 395, 108–112.
 21. Zoqui, E. J., “Morphological analysis of SSM Al–4.5 wt.% Cu measured by the rheocast quality index”. *J. Mater Process Technol*, 2003, 143-144, 195–201.
 22. Saklakoglu, N., Saklakoglu, I. E., Tanoglu, M., Oztas, O. and Cubukcuoglu, O., “Mechanical properties and microstructural evaluation of AA5013 aluminum alloy treated in the semi-solid state by SIMA process”. *J. Mater Process Technol*, 2004, 148, 103–107.
 23. Flemings, M. C., “Solidification Processing”, *Metall. Trans. A*, 1991, 22, 957.
 24. Witten, T. A., Sander, L. M., “Diffusion-Limited Aggregation, a Kinetic Critical Phenomenon, *Phys*”. *Rev. Lett.*, 1981, 47, 1400-1403
 25. Doherty, R. D., Lee, H. I. and Feest, E. A., “Microstructure of stir-cast metals”, *Mater. Sci. Eng. A*, 1984, 65, 181-189.